

# COMPLETA

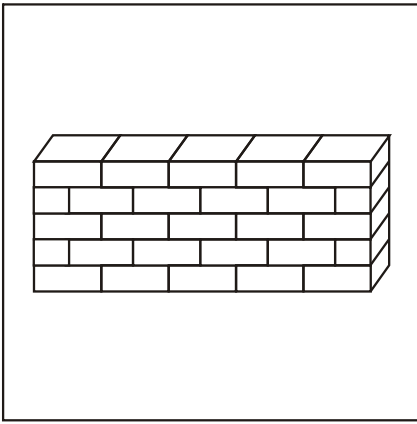

		R	O
		r	o

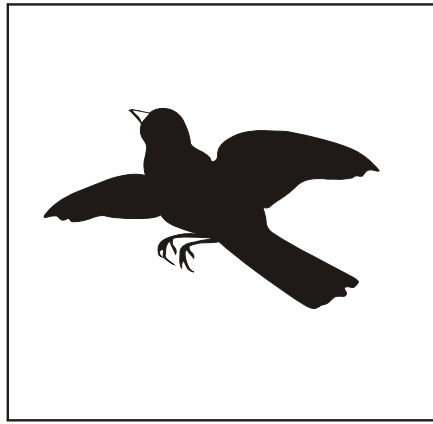

		R	L	O
		r	l	o

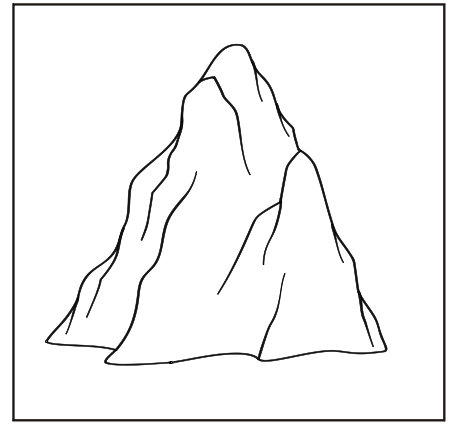

		N	T	E
		n	t	e

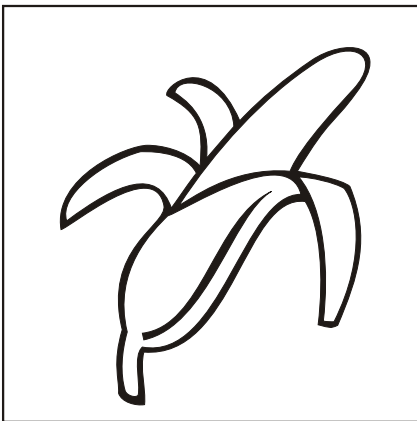

		N	A	N	A
		n	a	n	a

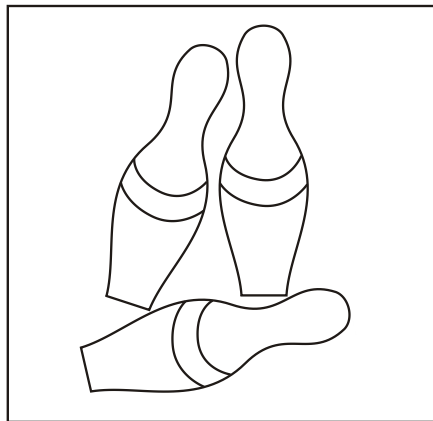

		R	I	L	L	I
		r	i	l	l	i

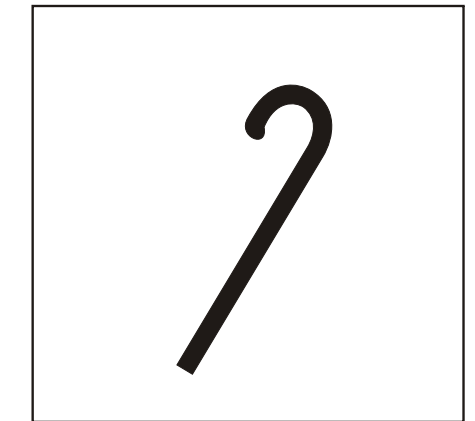

		S	T	O	N	E
		s	t	o	n	e

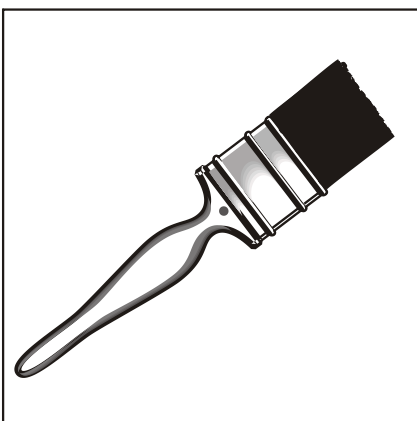

		N	N	E	L	L	O
		n	n	e	l	l	o

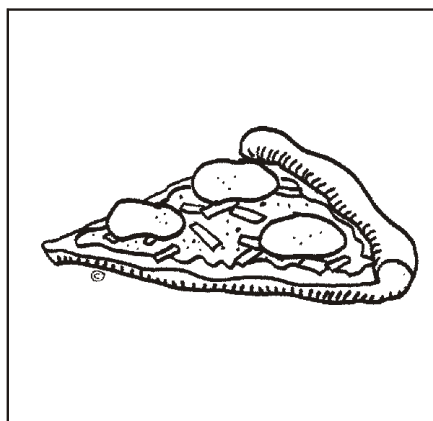

		Z	Z	A
		z	z	a

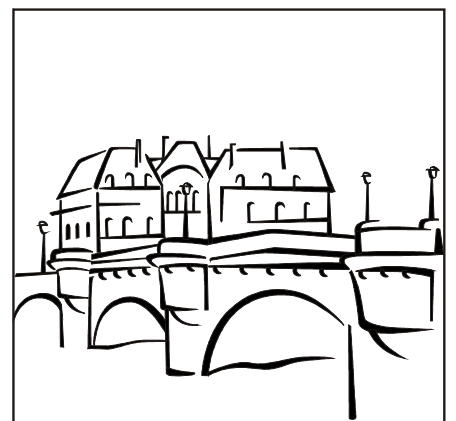

		N	T	E
		n	t	e

# COMPLETA

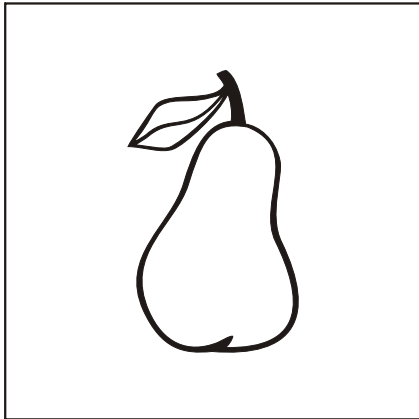

		R	A
		r	a

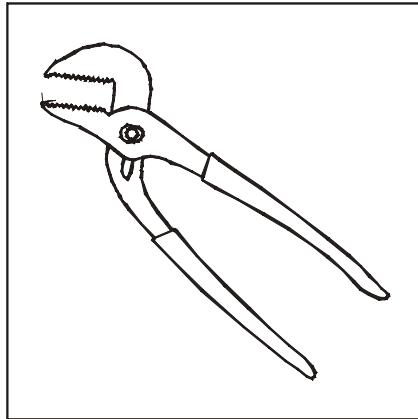

		N	Z	A
		n	z	a

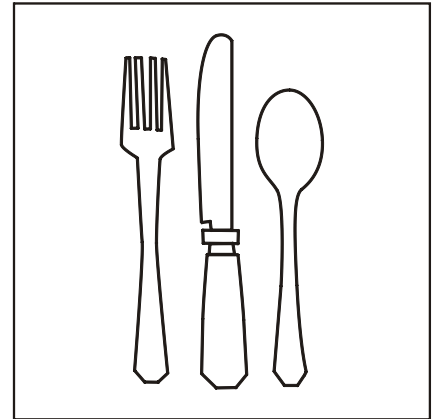

		S	A	T	E
		s	a	t	e

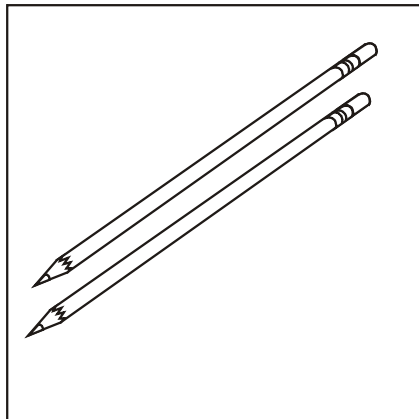

		T	I	T	E
		t	i	t	e

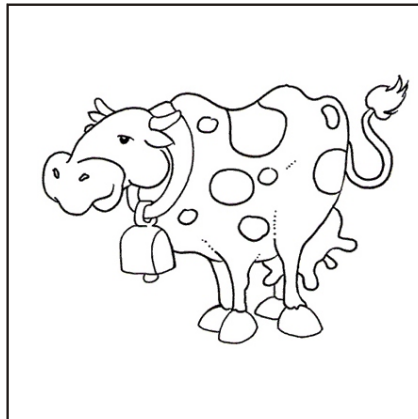

		C	C	A
		c	c	a

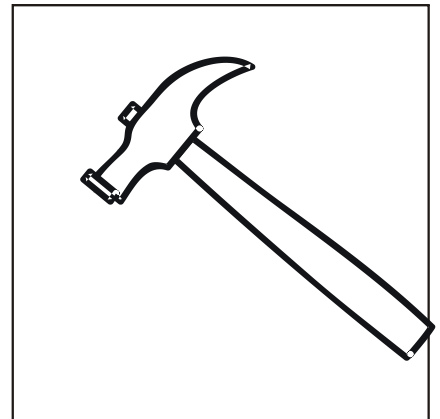

		R	T	E	L	L	O
		r	t	e	l	l	o

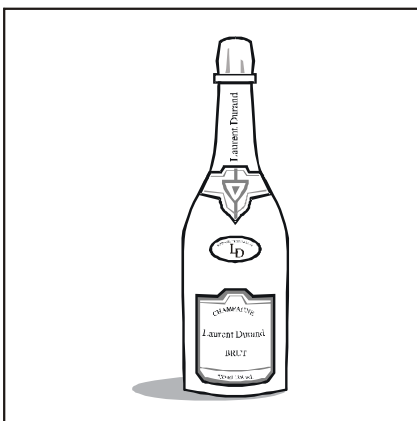

		T	T	I	G	L	I	A
		t	t	i	g	l	i	a

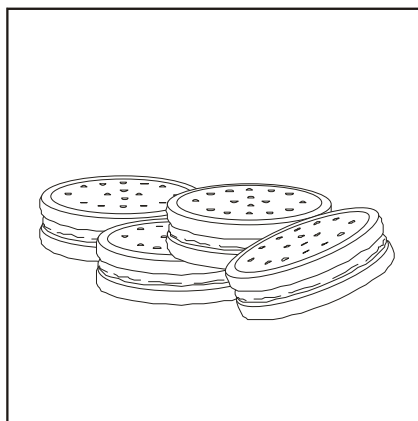

		S	C	O	T	T	I
		s	c	o	t	t	i

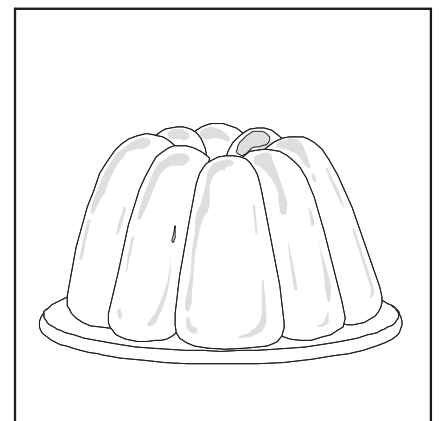

		D	I	N	O
		d	i	n	o

# COMPLETA

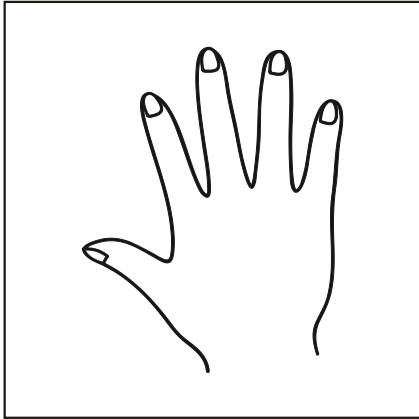

NO

no

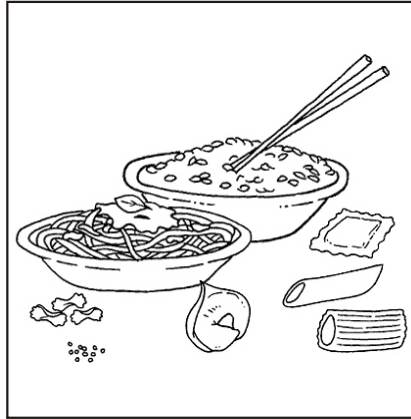

STA

sta

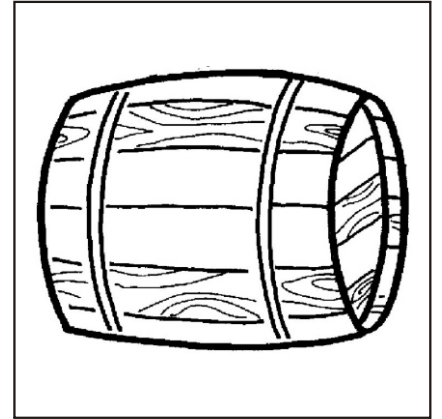

TTE

tte

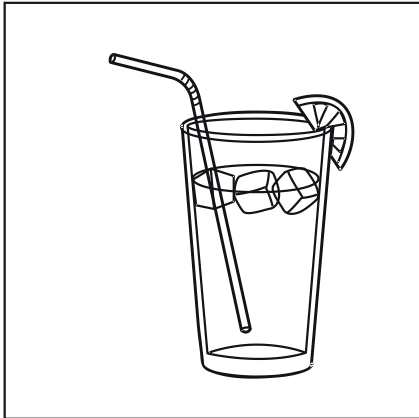

TA

ta

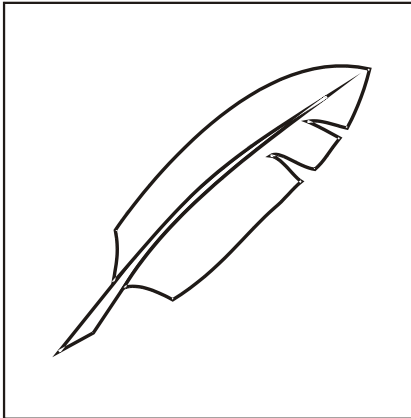

UMA

uma

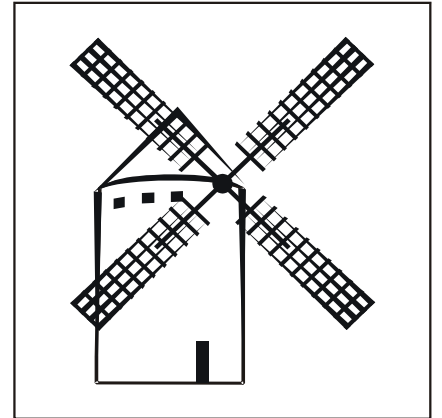

LINO

lino

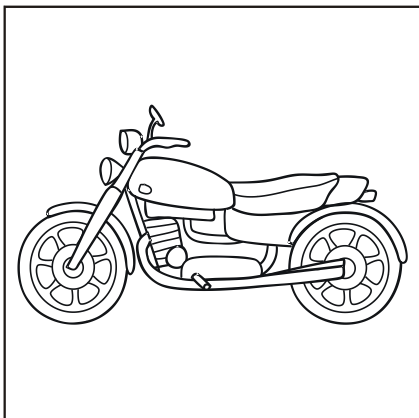

TO

to

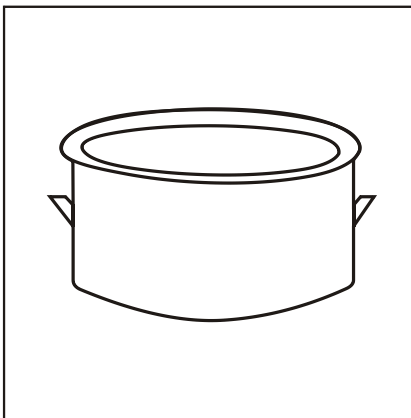

NTOLA

ntola

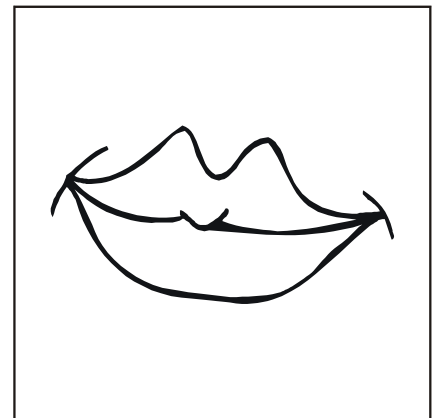

CCA

cca