

COMPLETA

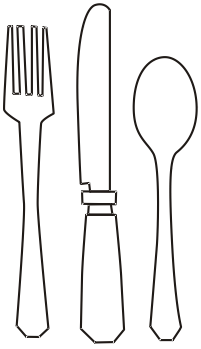

... ..SATE
... ..sate



... ..PONE
... ..pone



... ..MA
... ..ma

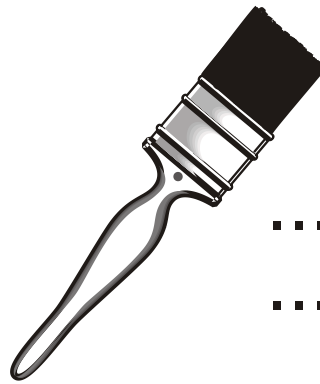

... ..NNELLO
... ..nnello

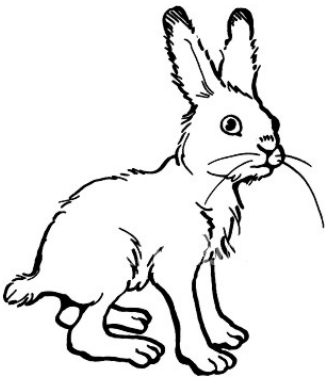

... ..PRE
... ..pre

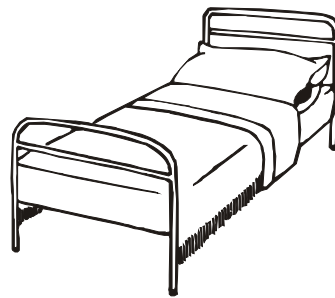

... ..TTO
... ..tto



... ..MPADINA
... ..mpadina

COMPLETA

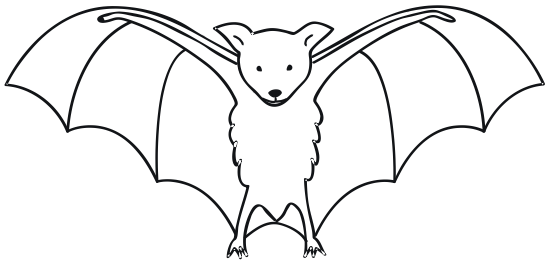

... ..STRELLO
... ..strello

... ..OPARDO
... ..opardo

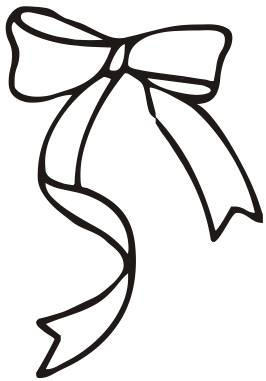
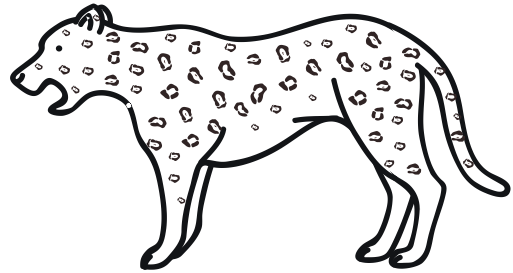

... ..STRO
... ..stro

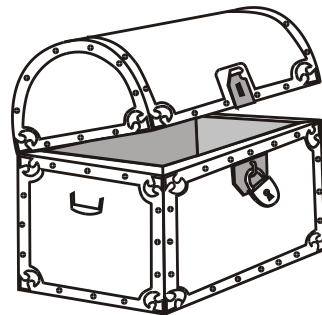

... ..ULE
... ..ule

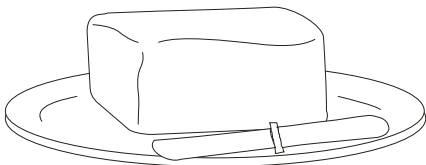

... ..RRO
... ..rro

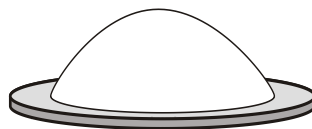

... ..LENTA
... ..lenta

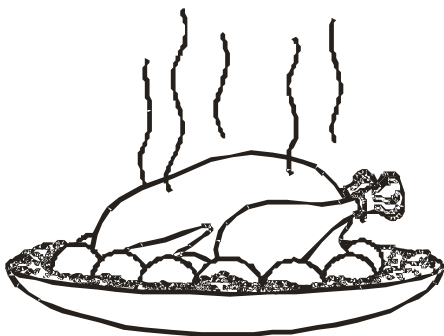

... ..LLO
... ..llo

... ..TTE
... ..tte

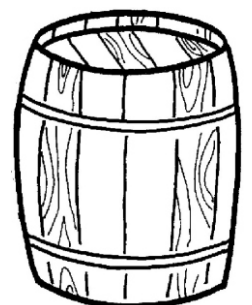

COMPLETA



... .. STORANTE
... .. storante

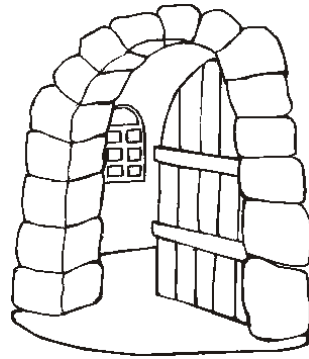

... .. RTONE
... .. rtone

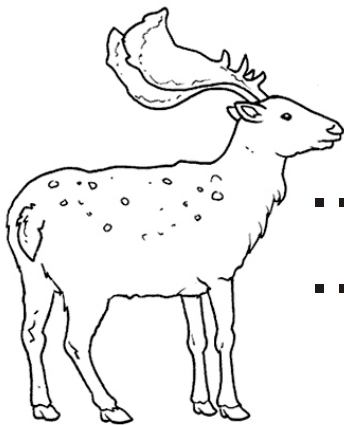

... .. INO
... .. ino

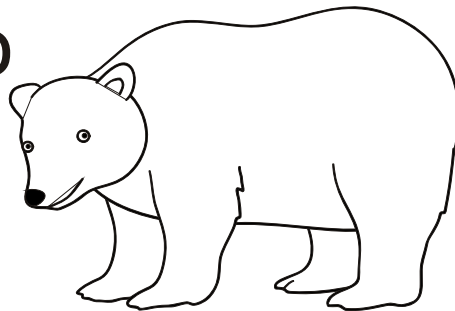

... RS ...
... rs ...

... .. PPAGALLO
... .. ppagallo

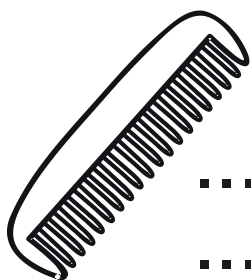

... .. TTINE
... .. ttine



... .. UME
... .. ume