

Completa C o G ?

(suono dolce)

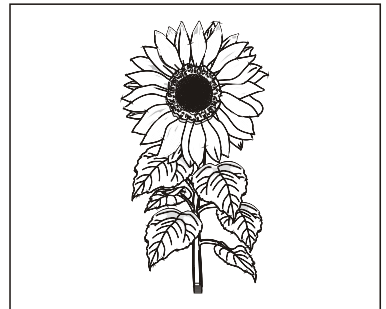
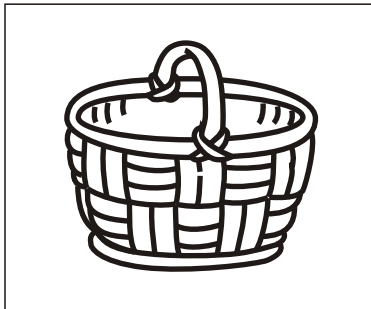
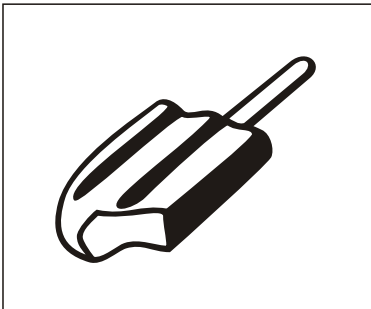
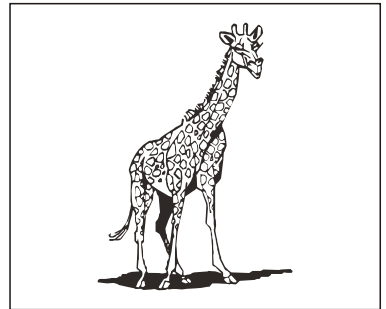
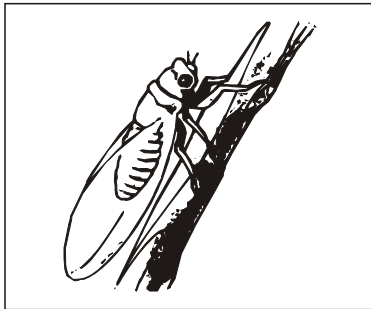
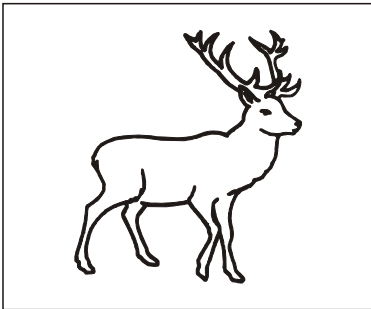
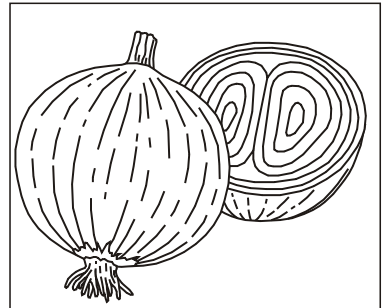
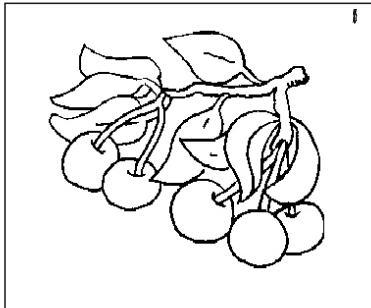
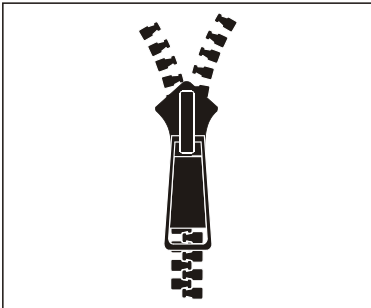
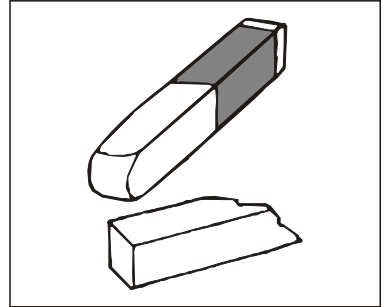
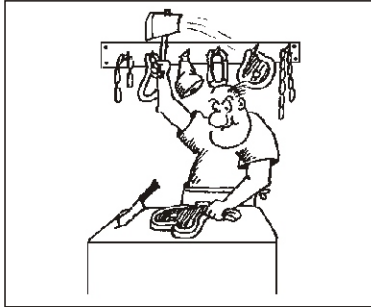

LEGGI E COMPLETA CON LA LETTERA GIUSTA:

C o G ?

... ERO

... ELATO

... IRCO

PA ...INA

LU ... E

... IMA

VI ... ILE

NO ... E

BA ... I

FU ... ILE

RE ... INA

... ENERE

CU ... INA

... ESSO

... INTURA